

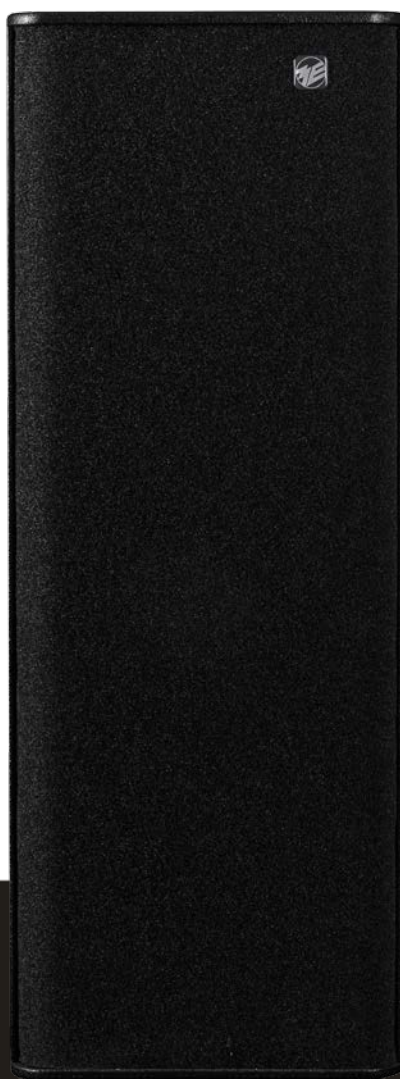

musikelectronic geithain

TS 37SP

TS 37KSP



Instructions for installation and use

Table of contents

1	Introduction	1
2	Disclaimer	2
3	System description	3
4	Specifications	4
4.1	Technical specifications	4
4.2	Acoustical diagramms	6
4.3	Technical drawings	7
5	Basic information	9
5.1	Guidelines	9
5.2	Disposal	9
5.3	Safety instructions	11
5.4	Delivery contents	14
5.5	Cleaning	14
5.6	Environmental conditions	14
5.7	Guarantee acknowledgements	14
6	Controls and connections	15
7	Installation and operation	17
7.1	Mounting and positioning	17
7.2	Starting up the speakers	18
7.3	Wiring	19
7.4	Cable connection	19
8	Operation and configuration of the device	20
8.1	Desktop software ME Geithain DSP Control	20
8.2	Menu structure	20
8.3	Home screen	20
8.4	Preset menu	21
8.5	Channel menu	22
8.6	Entering names and passwords	24
9	User rights	25
10	Troubleshooting	26
11	Notes	27

1 Introduction

Dear customer,

Thank you for the trust you have put in us by buying these speakers. You decided upon a quality product that in regard to tonal and technical characteristics complies to the utmost expectations.

The usual burn-in period is not required, because the speakers are artificially aged in-house.

Please read the technical description and manual to take advantage of the capabilities of these speakers and ensure safe operation.

2 Disclaimer

Technical data and appearances are subject to changes without notice. Errors and omissions excepted. Musikelectronic Geithain GmbH assumes no liability for any loss which may be suffered by any person who relies either wholly or in part upon any description, photograph or statement contained herein. Musikelectronic Geithain GmbH products are sold through authorized fulfillers and resellers only. Fulfillers and resellers are not agents of Musikelectronic Geithain GmbH and have absolutely no authority to bind Musikelectronic Geithain GmbH by any express or implied undertaking or representation. This manual is copyrighted. No part of this manual may be reproduced or transmitted in any form or by any means, electronic or mechanical, including photocopying and recording, or by any information storage or retrieval system without the prior written permission of Musikelectronic Geithain GmbH.

All rights reserved

Copyright © 2018 Musikelectronic Geithain GmbH

3 System description

The active two-way reinforcement systems TS37KSP and TS37SP feature linearity and high dynamics. As an all-round system they are useful for speech and music reproduction in middle and large sized auditoria and are the right decision when systems with high levels are needed. The active concept allows flexible adjustments to acoustical conditions and guarantees a perfect combination of speakers and amplifiers. Thanks to pre-programmed presets a combination of our active subwoofers and speakers saves the time to configure a loudspeaker management system and immediately offers a perfectly adjusted system.

The components include two 10-inch cone woofers and one 1.4-inch compression driver. Both are effectively secured from destruction by an internal limiter. During development the high frequency sound transmission was optimised for smallest possible colouration. The bass reflex version TS37SP reaches a lower cut-off frequency of 65Hz. The resulting bass level enables the use as a full-range system in many situations. Optionally our TT-subwoofers can be employed to extend the bass transmission range more than one octave. The waveguide of the horn driver is available in two opening angles and is also mountable rotated through 90°. So the speaker becomes flexibly usable and is as well variable regarding the mounting position.

A variety of available mountings provide easy assembly for almost every application.

4 Specifications

4.1 Technical specifications

Cabinet type	
TS37SP	vented cabinet
TS37KSP	cardioid directivity in low frequencies
Maximum SPL	129 dB _{peak} / r = 1 m (3'3")
Frequency response	
TS37SP	65 Hz ... 20 kHz -6 dB
TS37KSP	100 Hz ... 20 kHz -6 dB
Coverage angle f > 2 kHz	90° × 60° (H × V) 60° × 40° (H × V)
Transducers	
LF	2 × 10" cone
HF	1 × 1.4" compression driver
Calibration	
Acoustic output level / P _E = -14 dBu	99 dB _{SPL} / r = 1 m (3'3")
Mains voltage	85 V ... 260 V
Power consumption	
Maximum	800 W
No-load	25 W
Stand-by	16 W
Mains connectors	1 × Powercon 1 × Powercon loop-through output
Amplifier type	2-channel PWM amplifier with temperature controlled fan
Nominal output power	2 × 300 W
Maximum output power	2 × 450 W
Noise level	≤ 9 dB(A) / r = 1 m (3'3")
Inputs	1 × XLR analogue
Input level	-6 dBu ... +6 dBu
Outputs	1 × XLR analogue
Control inputs	1 × RJ45 Ethernet 1 × USB
Electronic crossover frequency	1.9 kHz
Directivity index	see diagram
Equalizer	10 free programmable parametric EQs
Delay	up to 800 ms
Dimensions (h × w × d)	860 × 320 × 370 mm (33.9" × 12.6" × 14.6")

Weight	30 kg (66.2 lbs)
Environmental specifications	
Operating temperature	+15 °C ... +35 °C (+59 °F ... +95 °F)
Storage temperature	-25 °C ... +45 °C (-13 °F ... +113 °F)
Relative humidity	45 % ... 75 %
Design of the cabinet	lumber core plywood with scratch proof structure coating black RAL9005, other colours on request
Additional accessories (optional)	security lug stand, wall and ceiling mount elements

4.2 Acoustical diagrams

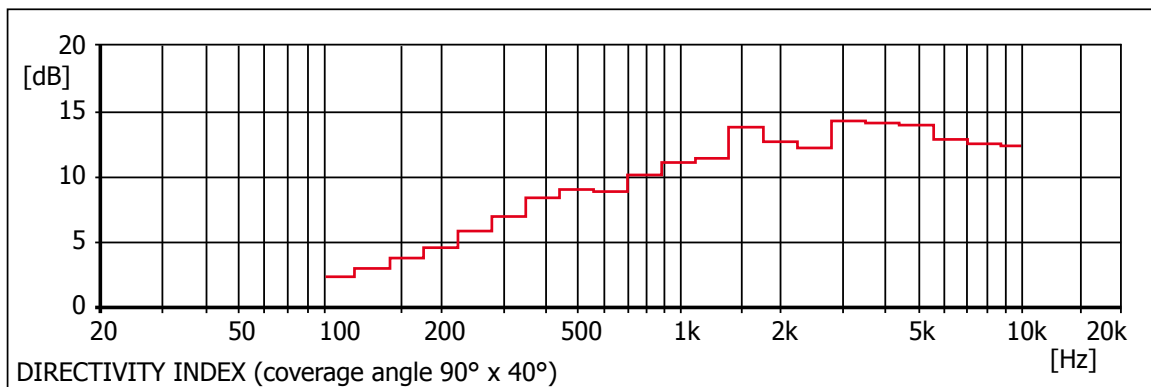
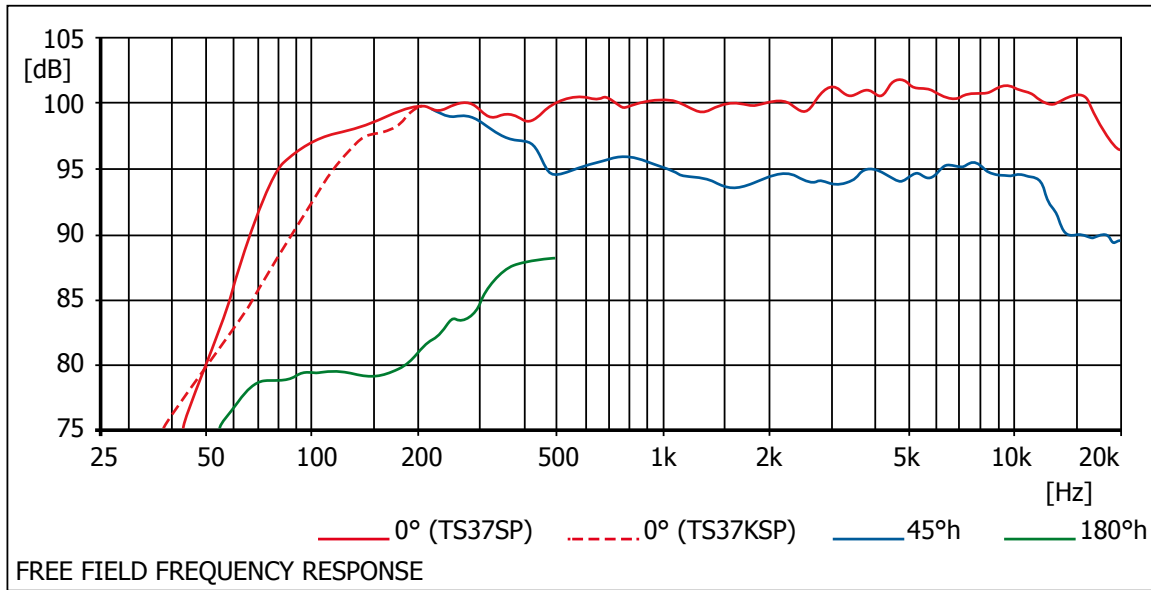

4.3 Technical drawings

4.3.1 TS37SP

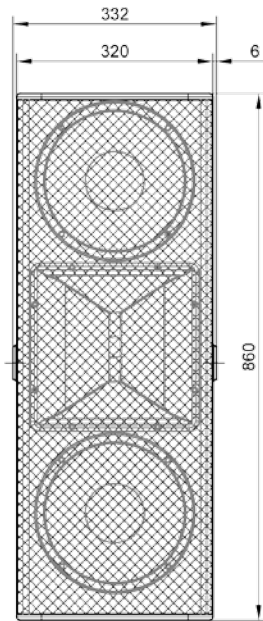

Front view

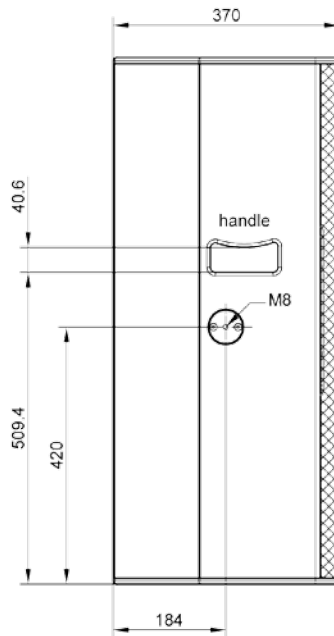

Side view

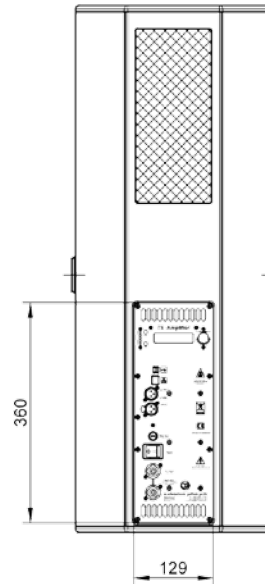

Rear view

Top view

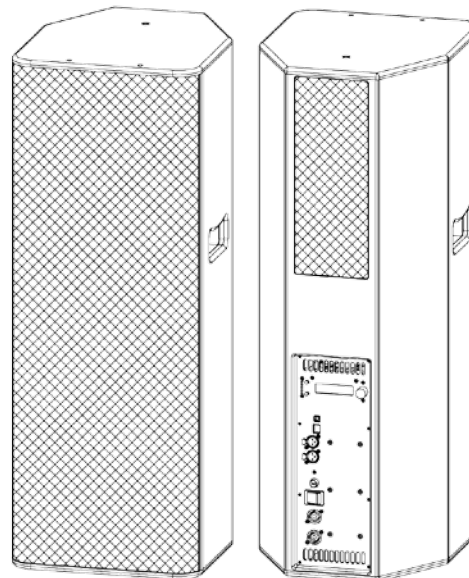
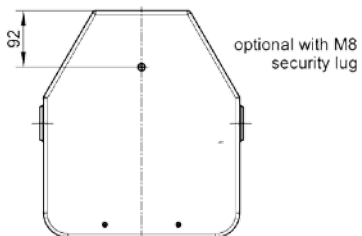

4.3.2 TS37KSP

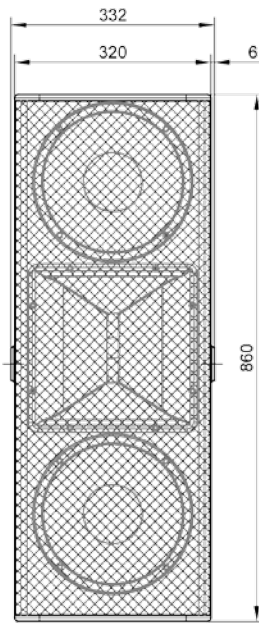

Front view

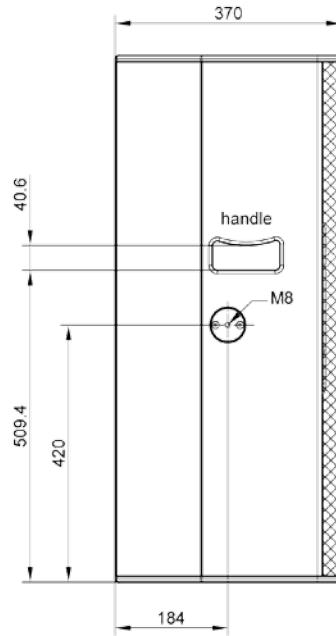

Side view

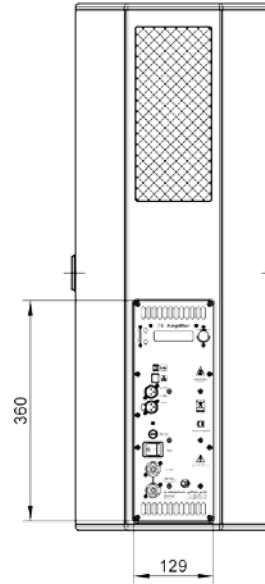

Rear view

Top view

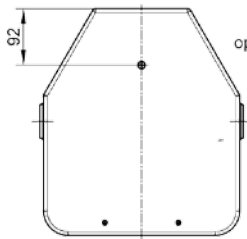

optional with M8 security lug

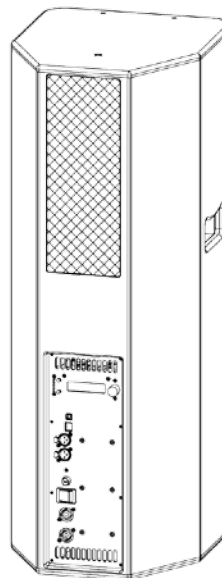
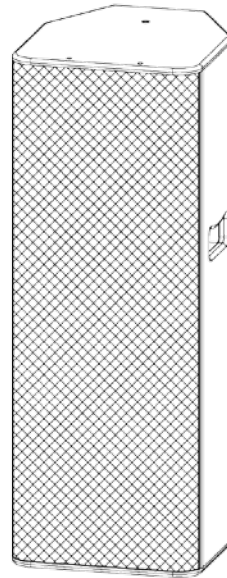

5 Basic information

5.1 Guidelines

This product complies to requirements of current European and national guidelines. The conformity is ascertained, corresponding declarations and records are deposited with the manufacturer.

EC Declaration of Conformity in accordance to EC Directives

- ◀ Electromagnetic Compatibility (2004/108/EG)
- ◀ Low Voltage Directive (2006/95/EG)

This product conforms to the following standards:

- ◀ EN55103-1 Emission
- ◀ EN55103-2 Immunity

5.2 Disposal

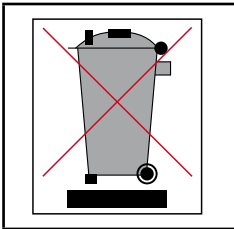

Products built by us belong to B2C-class of the WEEE guidelines and must not be disposed with domestic waste.

5.2.1 Germany

It is not allowed to dispose of used electrical equipment as domestic waste.

Non-reusable parts of the mounting accessories have to be disposed according to national environmental regulations.

Ensure disposal of damaged mounting accessories before they could be reused.

But do not dispose these products and accessories at official collecting points for recycling either!

Disposal of Musikelectronic Geithain GmbH products labelled with a waste bin sign have thus to be disposed of by Musikelectronic Geithain GmbH alone. Please call Musikelectronic Geithain GmbH at the number stated below if you have a Musikelectronic Geithain GmbH product to be disposed. We will offer you a straightforward and professional disposal not affecting cost.

If there is no waste bin sign on one of your Musikelectronic Geithain GmbH products, because they have been sold before March 2006 then by law the owner is in charge of the disposal. For these we will be happy to assist and offer you proper ways of disposal.

Declaration: With the ElektroG (law relating to electrical and electronic equipment and appliances) we have complied with the EU-directive on waste electrical and electronic equipment (WEEE, 2002/96/EC).

The Musikelectronic Geithain GmbH has thus labelled all products mentioned in the WEEE from 03/24/2006 onwards with a sign with a crossed out waste bin and a white bar below. This sign indicates that the disposal into the domestic waste is prohibited and that the product has been put into circulation at the 03/24/2006 earliest.

The Musikelectronic Geithain GmbH has been legally registered as a manufacturer with the registration office EAR. Our WEEE registration No. is: DE 72 4045 19

5.2.2 EU, Norway, Iceland and Liechtenstein

It is not allowed to dispose of used electrical equipment as domestic waste.

The Musikelectronic Geithain GmbH has thus labelled all products coming from EU-Member countries as well as Norway, Iceland and Liechtenstein (except Germany) mentioned in the WEE from 08/13/2005 onwards with a sign with a crossed out waste bin and a white bar below. This sign indicates that the disposal into the domestic waste is prohibited and that the product has been put into circulation at the 08/13/2005 earliest.

Unfortunately the European directive WEEE has been complied with implementing different national provisions of law throughout all member countries, which makes it impossible for us to offer consistent solutions for the disposal throughout Europe.

Responsible for complying with these provisions of law is the local distributor (importer) of each country.

For proper disposition of used products in accordance with these local provisions in the mentioned countries of the European Union (except Germany) please ask your local dealer or the local authorities.

5.2.3 Other countries

For proper disposition of used products in accordance with these local provisions in other countries please ask your local dealer or the local authorities.

5.3 Safety instructions

Like using any other electrical device you should observe the following operation guidelines, safety instructions and warning signs to ensure optimum functionality and safety of operation!

- ◀ Read these instructions carefully.
- ◀ Keep these instructions during the life cycle at a safe place. The instructions are an important part of the product.
- ◀ Heed all warnings. Follow all instructions.
- ◀ The product may only be used in accordance with the information provided in the user manual. Before and during the usage of the amplifier please ensure that all recommendations, especially the safety recommendations in the user manual, are adhered to.
- ◀ Do not place this product on an unstable cart, stand, tripod, bracket, or table. The product may fall, causing serious injury, and damage to the product.
- ◀ The heat sink must not be blocked or covered. This product should not be installed unless proper ventilation is provided or manufacturer's instructions have been adhered to.
- ◀ Do not install the device near any heat sources.
- ◀ Do not expose the device to direct sun radiation.
- ◀ Do not try to insert anything into device openings.
- ◀ Do not install the device in rooms with high humidity.
- ◀ The device shall not be exposed to dripping or splashing and no objects filled with liquids shall be placed on the device.
- ◀ Clean only with dry or slightly moistened cloth.
- ◀ Protect the power cord from being walked on, pinched or damaged in any other way. Pay particular attention to plugs and the point where they exit the device.
- ◀ Do not attempt to service this product yourself as opening or removing cover may expose you to dangerous voltage or other hazards.
- ◀ There is risk of electric shock when the device is open.
- ◀ Refer all servicing to qualified service personnel.

Water, rain, humidity and dust

The device is not protected against water, rain or excessive humidity and mustn't be exposed to these environmental conditions or operated next to them. Employ appropriate safety measures to prevent dust and dirt to get into the device. Dust and humidity are often the main reason for high voltage creepage paths and serious electrical dangers.

Maintenance

Unplug the device from the mains supply and refer to your authorised retailer or authorised repair and maintenance shop or the manufacturer. Maintenance is only allowed by one of the stated groups, because opening or removing the cover could expose you to dangerous voltages or other dangers. Maintenance is required when ...

- ◀ ... liquid has been spilled or objects have fallen into the device,
- ◀ ... the device has been exposed to rain or moisture,
- ◀ ... the device has been dropped or suffered damage in any other way,
- ◀ ... the device exhibits a distinct change from its normal function or performance.

Repair and replacement parts

All service and repair work must be carried out by an authorised retailer or an authorised repair and maintenance shop or the manufacturer. When replacement parts are required, please ensure that only replacement parts specified by the manufacturer are used. The use of unauthorized replacement parts may result in injury and/or damage through fire or electric shock or other electricity-related hazards.

Transport

To ship this device, always use the original shipping carton and packaging materials. For best protection pack it the same way as the manufacturer.

Environments

Use this product only in E1, E2, E3 or E4 environments according to EN55103-2 "Electromagnetic compatibility – Product family standard for audio, video and audio-visual and entertainment lighting control apparatus for professional use – Part 2: Immunity".

Air vents and heat sink

The air vents and the heat sink are provided to ensure reliable operation of the device and to protect it from overheating. The air vents and the heat sink must not be blocked or covered. This device should not be installed unless proper ventilation is provided or manufacturer's instructions have been adhered to.

Cleaning

Unplug the device from the wall outlet before cleaning. Do not use liquid or aerosol cleaners.

Correction of damages to the coating / changing the front foam

Although the used coating is highly resistant, the use of protective covers or flight cases is recommended to avoid damages during transport. If damages to the coating occur despite these precautions, the coating could be restored with acrylic paint in the same RAL colour as the speaker.

Power-cord protection

Power supply cords should be routed so that they are not likely to be walked on or pinched by items placed upon them or against them, paying particular attention to cords and plugs, and the point where they exit from the device.

Lightning

For added protection of the product during lightning storms, or when it is left unattended and unused for long periods of time, unplug it from the wall outlet. This will prevent damage to the product due to lightning and power-line surges.

Interference of external objects and/or liquids with the appliance

Never push objects of any kind into this product through openings as they may touch dangerous voltage points or short out parts that could result in a fire or electric shock. Never spill liquid of any kind on the device.

Connecting

When you connect the device to other equipment, turn off the power and unplug all of the equipment from the supply source. Failure to do so may cause an electric shock and serious personal injury. Read the user's manual of the other equipment carefully and follow the instructions when making the connections.

Sound level

Reduce the level to minimum before you turn on the speaker to prevent sudden high levels of noise which may cause hearing or speaker damage.

Power failure

In case of power failure while the amplifier is powered up, it will automatically restart as soon as the mains supply is restored. All settings made before the power failure are restored.

Speakon connectors and Speakon cords

To prevent electric shock, do not operate the product with any of the conductor portion of the speaker wire exposed.

Employ appropriate safety measures when connecting the power cord. When installing or connecting the product, disconnect it from mains supply. The product mustn't be connected to other alternating voltages and sockets than demanded on the back of the device.

IMPORTANT: Only off-the-shelf cables are allowed to be used to connect the product to mains.

IMPORTANT: To disconnect the product from mains, first disconnect the power cord from the socket, and then remove the cable from the product.

THE MAINS CONNECTION MUSTN'T BE DISCONNECTED FROM PROTECTIVE EARTH. THAT'S ILLEGAL AND DANGEROUS!

Unboxing

The speakers are shipped in proper condition. Unpack the speaker carefully and check for visible damages. In case of damages report them to your retailer. Keep the packaging, in case the speaker has to be transported in the future.

To unpack the device please refer to the additional user manual for unboxing.

5.4 Delivery contents

- ◀ Speaker TS37SP or TS37KSP
- ◀ Powercon cable
- ◀ Technical description and user manual

5.5 Cleaning

The speaker is made of real wood veneer and needs to be nurtured in the same way as furnishings. We advise quality wax polish to ensure durability of the veneer. Surfaces can also be cleaned with tidy, slightly dampened, fuzz-free, smooth cloth.

5.6 Environmental conditions

Ensure the following environmental conditions in your listening room:

- ◀ Operating temperature +15 °C ... +35 °C (+59 °F ... +95 °F)
- ◀ Storage temperature range -25 °C ... +45 °C (-13 °F ... +113 °F)
- ◀ Relative humidity 45 % ... 75 %

5.7 Guarantee acknowledgements

Opening the device by unauthorized personnel leads to all claims under guarantee expire. In case of destruction by overload, misuse or outside influences there are no claims under guarantee.

6 Controls and connections

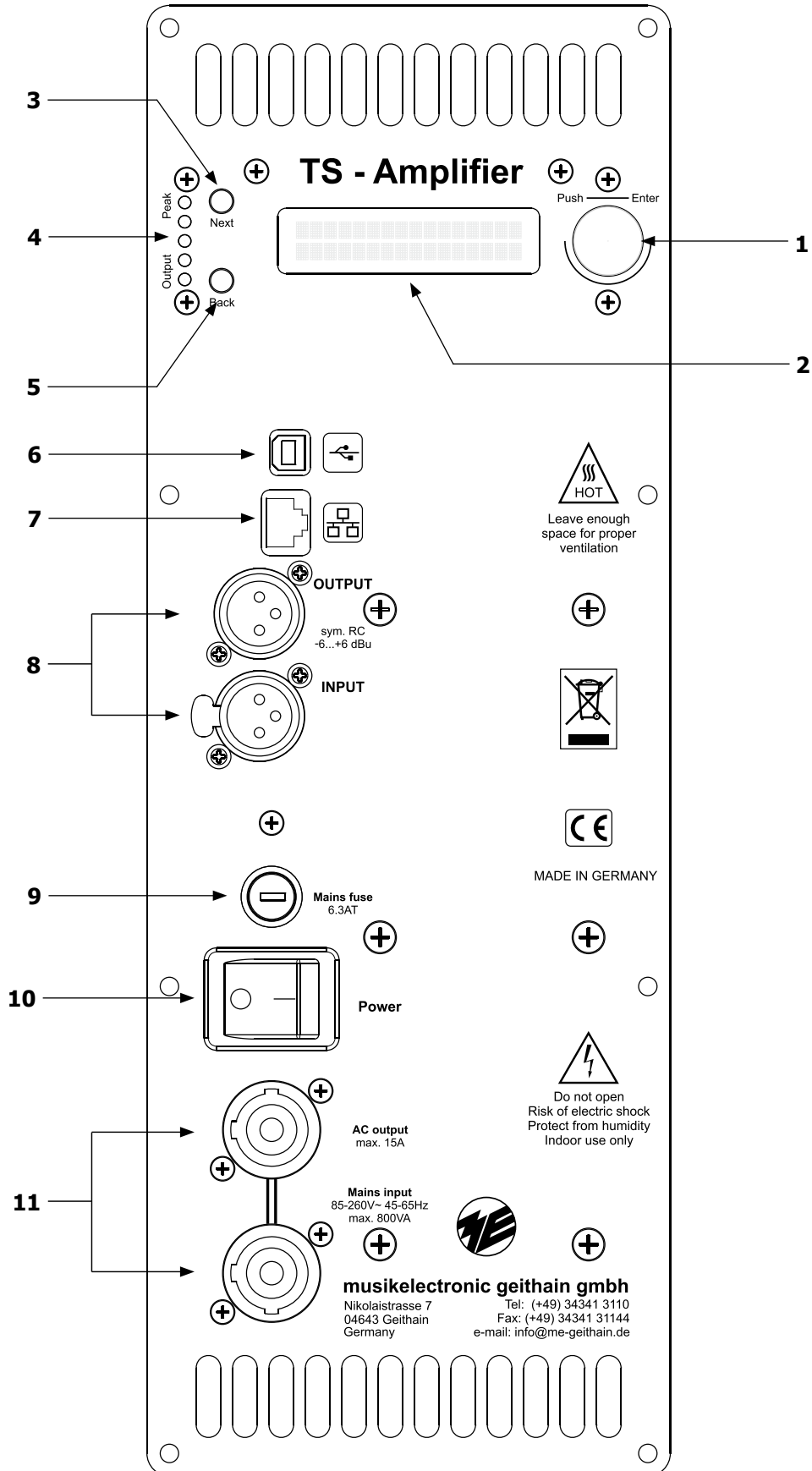

Rotary encoder (1)

Controls the device and is used to navigate the menu and to set parameters (see chapter "8 Operation and configuration of the device", page 20).

LCD display (2)

A 2 × 20 digits display shows user interactions and status. During action it could be dimmed or even shut down.

NEXT button (3)

Controls the device and is used to navigate the menu and to set parameters (see chapter "8 Operation and configuration of the device", page 20).

LED-level indicator (4)

Indicates the level on the device in case of limiting or clipping.

BACK button (5)

Controls the device and is used to navigate the menu and to set parameters (see chapter "8 Operation and configuration of the device", page 20).

USB port type B (6)

Used to configure the device with the software ME Geithain DSP Control.

Ethernet port 10/100 Mbit/s RJ45 (7)

Configuration interface for remote access with ME Geithain DSP Control through a standard TCP/IP network.

LINE In-/Output XLR3 F/M (8)

Symmetrical in and / or output connectors, for input signals up to +6 dBu.

Fuse carrier (9)

Fine wire fuse with 6.3A T, 6,3 × 32 mm, turn left to lock, turn right to release.

On/Off switch (10)

This switch disconnects mains and completely turns off the device.

Mains supply with Powercon In/Out (11)

Connection to mains and the possibility to power up another speaker with max. 15A.

7 Installation and operation

During installation ensure sufficient convection at the heat sink.

7.1 Mounting and positioning

7.1.1 Changing the coverage angle of the horn driver

The horn drivers are designed with a square horn mouth and can be rotated to change the coverage angle. By default, the horn drivers are built-in for a wide horizontal coverage angle.

To widen the coverage angle of the horn driver vertically, the horn can be rotated in the housing. This reduces the horizontal coverage angle. For this purpose, the screws (PH2) at the top and bottom of the device must be removed, which hold the foam-covered front grille. The grille can then be removed carefully. The horn is released by removing further screws (PH2) and then rotating it by 90°. Afterwards the horn is screwed back on, the grille is placed on the device and also screwed back on.

7.1.2 Instructions for mounting and suspension of speakers

Refer suspending the speakers to trained and qualified personnel.

Heed all warnings and instructions of the speakers and mounting accessories as well as national regulations.

Every speaker is to be suspended with a second independent flying point. This applies also to speakers principally suspended on two flying points. The additional protection suspension has to be attached in that way that in case of failure of the primary suspension the secondary suspension is holding the speaker without falling or swinging. Ensure that all connections are secured to prevent their detaching on their own and that only admissibly statically tested and sufficiently sized connecting devices, ropes and chains are used.

7.1.3 Mounting instructions for speakers

Speakers are to be mounted in a way, so that they cannot fall and cause damages to environment or persons. Therefore stacked speakers are to be secured with safety straps. Connecting cables have to be installed so that nobody trips.

Stability of stacked systems (including stands and distance rods) is ensured, when the following requirement is fulfilled:

Stacked systems may not fall even if they are inclined more than 10° in any direction. To fulfil this requirement take measures to achieve compliance. One possibility is strapping the stacked speakers to a solid base or using safety straps.

7.1.4 Accurate alignment of the speakers

The environment heavily influences the result of the sound reinforcement, so absolute statements are not possible. A proper alignment of the speakers leads to hearable increases in quality.

Mid and high range systems should be installed above height of head of the audience to prevent shadowing of sound. A lower installation height results in greater differences in level between front and back seats compared to speakers with higher installation height. Please note that this is just a general guideline and the best possible result may vary from room to room.

7.1.5 Mounting and fastening elements

Mounting and fastening elements for ceiling, wall or stand installation as well as user specific solutions are available from the retailer or manufacturer.

7.2 Starting up the speakers

Each time a visual inspection and functional check is recommend before starting up the speakers. If there are doubts regarding proper operating condition or safety of the speaker, the speaker mustn't be used.

When chain hoists are in operation ensure nobody is directly underneath or in the vicinity to the load.

7.2.1 Visual inspection

To reduce risk of accidents by failure or dysfunction of a component all systems need regular checks.

- ◀ visual inspection of all outside parts for obvious damage (e. g. scratches, damages of any kind)
- ◀ visual inspection of all mounting accessories for obvious damage (e. g. scratches, corrosion)
- ◀ inspection of front grille and foam for secure attachment
- ◀ regular lubrication of all sockets with WD-40 or similar products

7.2.2 Functional check

- ◀ When the system is ready for operation turn up the level on the mixing console. Then the levels of the top cabinets and bass systems should be balanced.
- ◀ Adjustment of the systems is also possible without the software ME Geithain DSP Control directly with the controls at the TS...SP speakers.
- ◀ Before switching off the system all speakers should be disconnected from mains. After that switch off the remaining equipment.

7.3 Wiring

- ◀ Turn off all equipment and ensure the speakers are not connected to mains supply.
- ◀ Use only cables complying with national security regulations. Before use, inspect the cables for obvious damages (e.g. through bends).
- ◀ Switch on peripheral devices (mixing consoles, effects, etc.) first, speakers should be the last devices to be switched on. Stick to this order, otherwise switching noises could damage the systems.
- ◀ In case of noise, turn off all devices in reverse order and check all cable connections. After that switch on the other peripheral devices and check them for interferences.
- ◀ For long-term installations a permanent connection to the network is advisable, to ease the maintenance respective configuration capabilities of the speakers.
- ◀ Ensure all cables are installed in a way that nobody can trip over them.

7.4 Cable connection

The input of the integrated amplifier is electrically balanced. When your signal source also utilizes balanced connectors, please use a cable wired as stated in the table:

	Balanced connector (amplifier)	Balanced connector (signal source)	Unbalanced connector (signal source)
	XLR	XLR	RCA
Earth	Pin 1	Pin 1	Ring
Signal +	Pin 2	Pin 2	Tip
Signal -	Pin 3	Pin 3	Ring

When using a signal source with unbalanced outputs (RCA) you need to balance the connecting cables. This avoids hum and other noise interferences. The table and the following figure show the wiring.

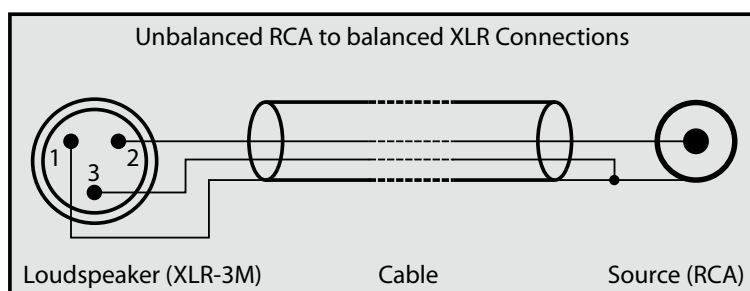

8 Operation and configuration of the device

The TS37SP or TS37KSP can be configured directly at the device or comfortably with a personal computer and ME Geithain DSP Control.

8.1 Desktop software ME Geithain DSP Control

For TS37SP or TS37KSP configuration and monitoring is possible via the integrated USB or RJ45 ports with a personal computer (IBM-PC or Macintosh). The according software as well as a user manual is available for download from the Musikelectronic Geithain GmbH website.

8.2 Menu structure

When the TS37SP or TS37KSP is switched on the display shows the Home screen with device name and currently loaded preset. Underneath is the Preset menu, used to load and save presets, show the serial number of the DSP module and switch to the LOCKED status. The signal processing parameters of the currently loaded preset are configured in the Channel menu. If there is no input in the lower levels the amplifier returns to the Home screen.

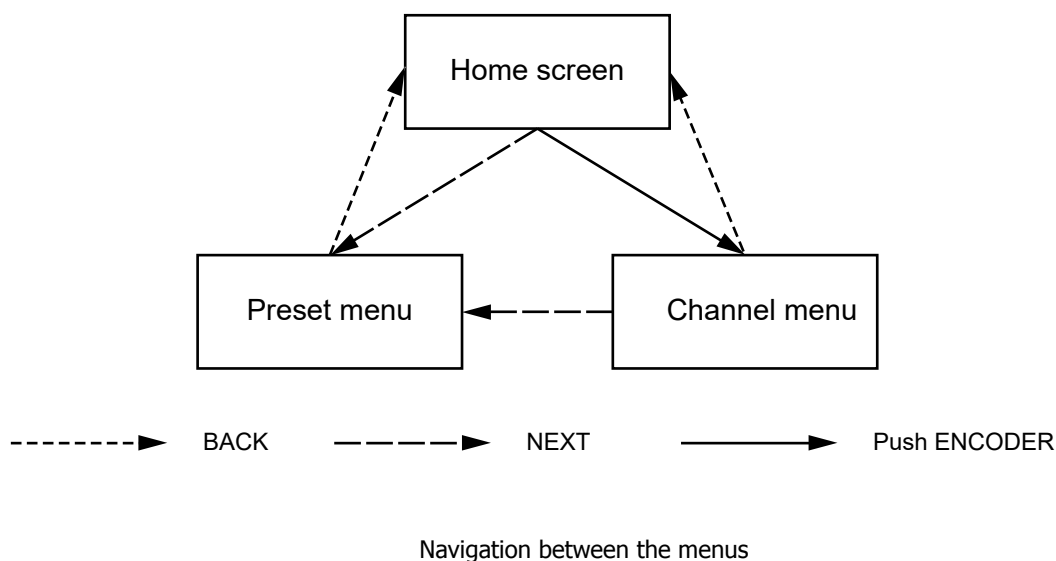

8.3 Home screen

In the first row of the display the Home screen shows the name of the device. In delivery conditions the name complies with the type of the speaker. The second row shows the number of the current preset, then the name of the preset. A "*" at the end of the line indicates that the TS37SP or TS37KSP is currently occupied (loading presets, synchronising with the PC software, etc.). Meanwhile controlling the device is not possible.

A "!" at the beginning of the first line indicates unsaved changes in the current configuration.

8.4 Preset menu

The preset menu is at any time accessible by pressing NEXT. The first menu item is LOAD to load a saved preset. Press NEXT again to go on through the preset menu. Turning the rotary encoder changes between presets and pressing it down loads the shown preset. Another menu item asks to confirm the decision by choosing YES and then pressing down the rotary encoder. Choose NO, press NEXT or BACK to abort the action and return to the Home screen. Preset number one in the device holds the factory settings. This preset cannot be overwritten so that it is always possible to restore the factory settings.

Handling the menu item SAVE works in the same way. After choosing a save location, insert a name for the preset. Chapter "8.6 Entering names and passwords", page 24, describes the procedure.

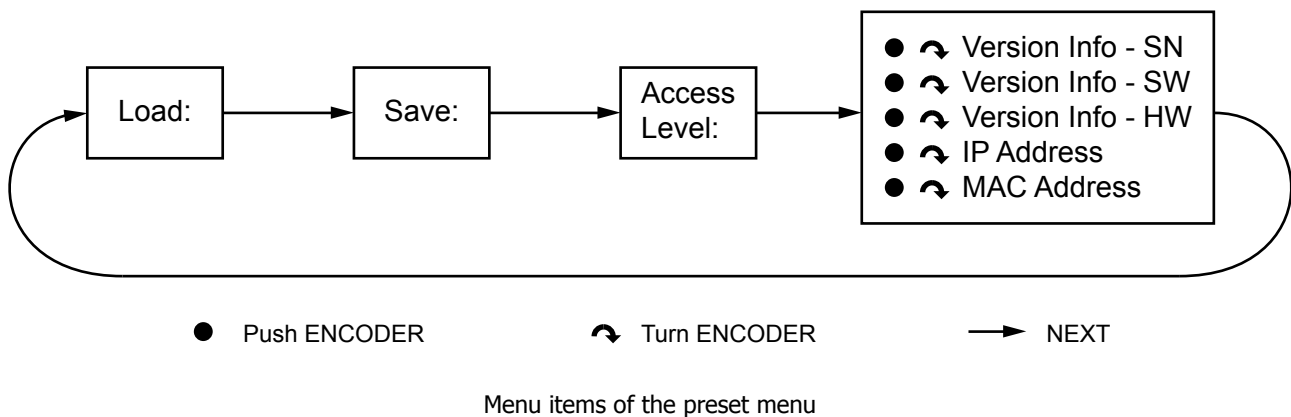

After menu item SAVE follows the access level. To choose the LOCKED status, insert a password according to the user level. In chapter "8.6 Entering names and passwords", page 24, is a description of the procedure.

The last menu item is the information panel. Turn the rotary encoder to browse through items showing the current hardware version, serial number of the DSP module, software version and the IP and MAC address of the device.

8.5 Channel menu

The channel menu is used to browse between the inputs and changing the parameters of the signal processing chain of the according channel. Enter the channel menu by pressing the rotary encoder. The first row shows the current input, an arrow, and the current item. When a left arrow is shown in the first row, the rotary encoder allows choosing an input. Press it down to confirm. When a right arrow is shown, choose a sub-item, shown in the first, similarly to selecting an input. If no arrow is shown between input and sub-item, the parameter is changeable through the rotary encoder. Pressing down the rotary encoder browses through the parameters if more parameters are available to this sub-item. Press NEXT or BACK to confirm any changes. Pressing NEXT redirects to the Preset menu. When pressing BACK, the right arrow reappears to enable choosing between sub-items. All changes remain stored until a new preset is loaded, even when the device is powered off.

The input channels are:

- ◀ In 1: analogue
- ◀ In 2: not used

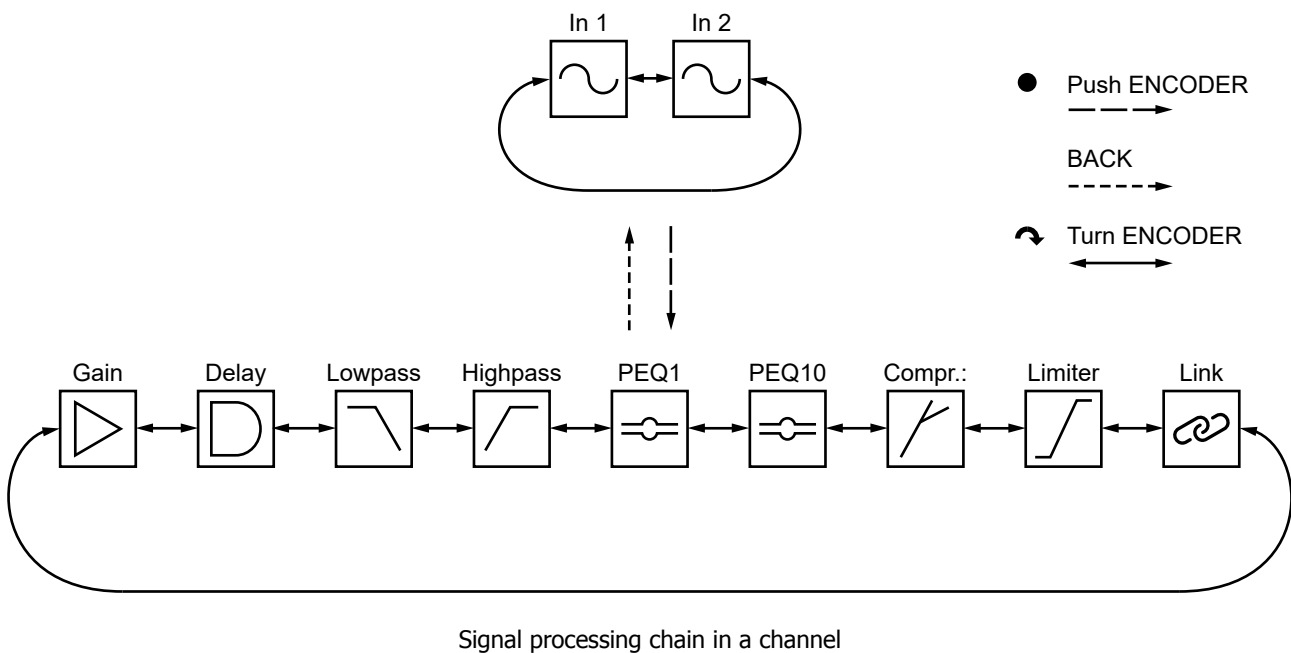

- Gain** Adjust the gain of the channel, e. g. to adjust the balance or volume between analogue and AES signals.
- ◀ Mute: -48 dB ... 12 dB
- Delay:** Delay every input signal, e. g. for compensation of different distances in a 5.1 set-up.
- ◀ 0 ... 800 ms
 - ◀ 0 ... 900.94 ft
 - ◀ 0 ... 274.6 m
- LowPass:** Use low-pass filtering on the input signal with different slopes, filter characteristics and variable frequencies.
- ◀ Freq: 50 Hz ... 20.000 Hz
 - ◀ Type: BUT 6, 12, 18, 24 dB; BES 6, 12, 18, 24 dB; LR 12, 24 dB
 - ◀ Enabled: Off ... On
- HighPass:** Use high-pass filtering on the input signal with the same parameters as the low-pass filter, e. g. filtering the low frequencies of the satellites in a 5.1 set-up.
- ◀ Freq: 20 Hz ... 20.000 Hz
 - ◀ Type: BUT 6, 12, 18, 24 dB; BES 6, 12, 18, 24 dB; LR 12, 24 dB
 - ◀ Enabled: Off ... On
- PEQ1 ... 10:** Parametric filters for adjustments to the room acoustics.
- ◀ Gain: -12 ... 12 dB
 - ◀ Freq: 20 Hz ... 20.000 Hz
 - ◀ Type: Bell, Notch, High Shelf, Low Shelf, Allpass, Band Pass, High Pass, Low Pass
 - ◀ Enabled: Off ... On
 - ◀ Q: 0,1 ... 25

Compressor: Compressor for the according channel.

- ◀ Thr.: -48 dBu ... 24 dBu
- ◀ Att.: 1 ... 10.000 ms
- ◀ Hold: 0 ... 10.000 ms
- ◀ Rel.: 1 ... 10.000 ms
- ◀ Ratio: 1,20:1 ... inf:1
- ◀ Gain: -12 dB ... 12 dB

Limiter: Limiter for the input signal.

- ◀ Thr.: -48 dBu ... 24 dBu
- ◀ Rel.: 10 ... 100 dB/s

Link: Use this option to group analogue and digital input signals so that the settings of the left channel are automatically copied to the right channel.

- ◀ Off ... On

8.6 Entering names and passwords

To insert strings like names and passwords through the panel, choose a digit with the rotary encoder and confirm by pressing the rotary encoder down. The cursor will then jump right to the next position. Press BACK and the cursor jumps back to the position to the left.

To confirm a name, press the NEXT button. To access a password protected function it is sufficient to enter the right password.

9 User rights

The device is divided into three user levels with different permissions: LOCKED, USER and ADMINISTRATOR. The levels USER and ADMINISTRATOR are password protected. The LOCKED level prevents changes to the configuration of the device by unauthorized personnel. The device could be started up in the LOCKED mode or USER mode.

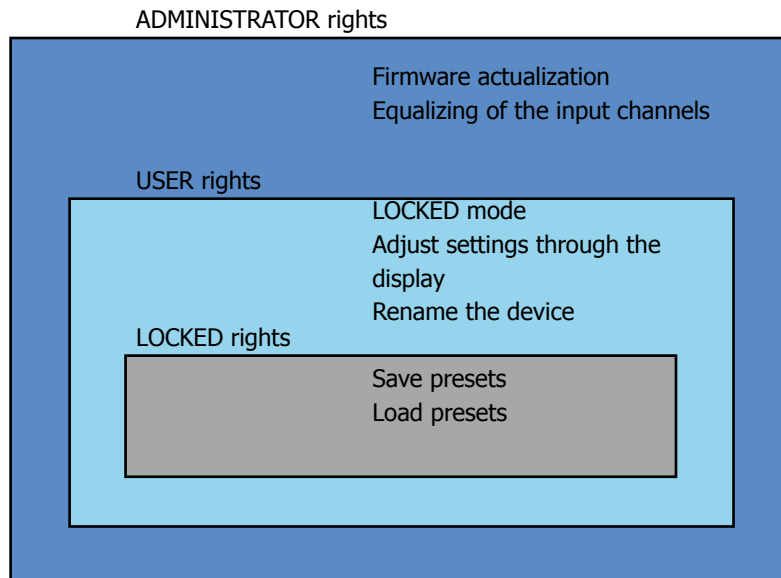

Standard passwords

- ◀ ADMINISTRATOR: TsAmAD7
- ◀ USER: tSAmPUr4

10 Troubleshooting

Error description	Possible causes	Corrective measures
Screen dark	Device in stand-by	Press any key
	Device is switched off	Ensure the device is switched on
No sound	Speakers are not connected correctly	Examine the XLR connections to the speakers
	In-/outputs are muted	Deactivate muting at the device or in the software
	No input signal available	Apply an analogue input signal
Network does not recognize the device	Network cable defect	Exchange the network cable
	No DHCP in the network	Connect the PC directly to the amplifier with a network cable and check the network settings of the device

11 Notes

BDA_TS37SP_15.05.2018_ENV07



musikelectronic geithain gmbh

STUDIO MONITORING - HIGHEND LOUDSPEAKER - SOUND REINFORCEMENT
SYSTEMS SYSTEMS

Nikolaistraße 7
04643 Geithain / Germany

Phone: +49 (0) 34341 3110
Fax: +49 (0) 34341 31144

Email: info@me-geithain.de

www.me-geithain.de